

FRIDRO

ALATI

07/26

Konusni trn

Važi do isteka zaliha



Konusni trn- futer

252-11...

Konusni trn

214-31...
M3010...

Set čaura tip ER i čaure za visok pritisak

SERIE-ER...

KINTEK[®]



Konusni trn- futer SK40/DIN 69871

DIN 69871 ADB

252-11301
252-11302



Preciznost 0.05mm
Pogoden za desnu i levu rotaciju do 7000 obrtaja u minuti

DIN 69871 ADB

252-11211
252-11212



Preciznost 0.05mm
Ne koristi se u okretanju u smeru suprotnom smeru kazaljke na satu

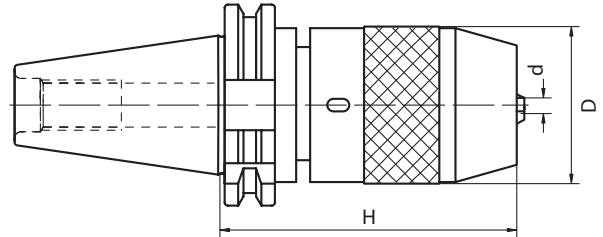

| Kat. br. | Oznaka | ISO | H | D | Opseg stezanja | Ključ | CENA |
|-----------|---------------|------|-----|----|----------------|------------|-----------|
| 252-11211 | TC40H95R1-13 | SK40 | 95 | 50 | 1-13 | 816-111024 | 15.480,00 |
| 252-11212 | TC40H115R3-16 | SK40 | 115 | 57 | 3-16 | 816-111025 | 16.820,00 |
| 252-11301 | TC40H90R1-13X | SK40 | 90 | 50 | 1-13 | 816-152001 | 22.170,00 |
| 252-11302 | TC40H95R3-16X | SK40 | 95 | 57 | 3-16 | 816-152001 | 23.220,00 |

Konusni trn- futer MAS BT40

JIS-B 6339 MAS 403/BT A

252-11501
252-11502



Preciznost 0.05mm
Ne koristi se u okretanju u smeru suprotnom smeru kazaljke na satu

JIS-B 6339 MAS 403/BT A - MAS 403BT/ADB

252-11410
252-11411

Preciznost 0.05mm
Pogoden za desnu i levu rotaciju do 7000 obrtaja u minuti



CENA od:
14.360,00

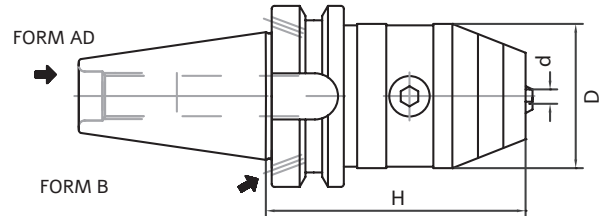

| Kat. br. | Oznaka | ISO | H | D | Opseg stezanja | Ključ | CENA |
|-----------|----------------|------|-----|----|----------------|------------|-----------|
| 252-11501 | BT40H95R1-13 | BT40 | 95 | 50 | 1-13 | 816-111024 | 14.360,00 |
| 252-11502 | BT40H115R3-16 | BT40 | 115 | 57 | 3-16 | 816-111025 | 15.420,00 |
| 252-11410 | BT40H98R1-13X | BT40 | 98 | 50 | 1-13 | 816-152001 | 22.170,00 |
| 252-11411 | BT40H103R3-16X | BT40 | 103 | 50 | 3-16 | 816-152002 | 23.220,00 |

Konusni trn- futer

DIN 69893 A+C

252-11733



Preciznost 0.05mm
Pogoden za desnu i levu rotaciju do 8000 obrtaja u minuti

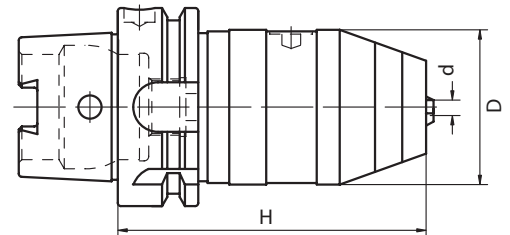

CENA
33.260,00

| HSK | Kat. br. | Oznaka | H | D | Opseg stezanja | Ključ | CENA |
|-----|-----------|------------------|-----|----|----------------|------------|-----------|
| 63 | 252-11733 | HSK63AH105R1-13X | 105 | 50 | 1-13 | 816-152001 | 33.260,00 |

JIS-B 6339 MAŠ 403/BT AD - **DIN6499/ISO15488**

214-31502

DIN 69871 AD - DIN6499/ISO15488

214-31202

CENA
5.350,00

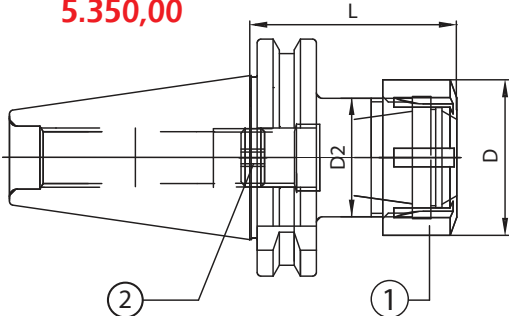

G6,3
15000 RPM

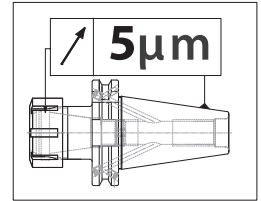
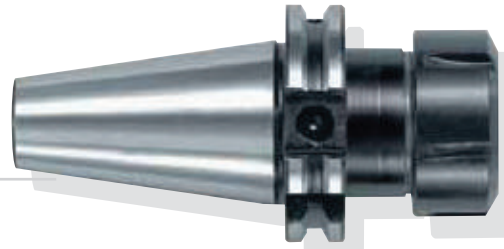

| Kat. br. | Oznaka | ISO | ER | D | D2 | L | CENA |
|-----------|-------------|------|----|----|----|----|----------|
| 214-31202 | TC40H70ER32 | SK40 | 32 | 50 | 40 | 70 | 5.350,00 |
| 214-31502 | BT40H70ER32 | BT40 | 32 | 50 | 40 | 70 | 5.350,00 |

Konusni trn HSK63

CENA
10.130,00

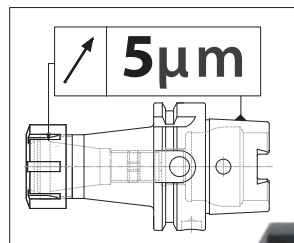
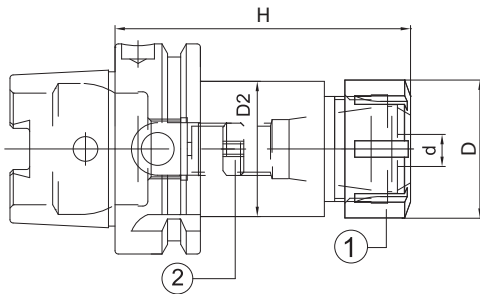

214-31707
214-31708

DIN 69893 A+C - DIN6499/ISO15488

G6,3
20000 RPM



| HSK | Kat. br. | Oznaka | H | d | D | ER | D2 | CENA |
|-----|-----------|----------------|-----|------|----|----|------|-----------|
| 63 | 214-31707 | HSK63AH100ER25 | 100 | 1÷16 | 42 | 25 | 41,5 | 10.130,00 |
| 63 | 214-31708 | HSK63AH100ER32 | 100 | 2÷20 | 50 | 32 | 49,5 | 10.130,00 |

Konusni trn za rezanje navoja

JIS-B 6339 MAŠ 403/BT A

M3310

DIN 69871 A
M3010

CENA od:
15.480,00

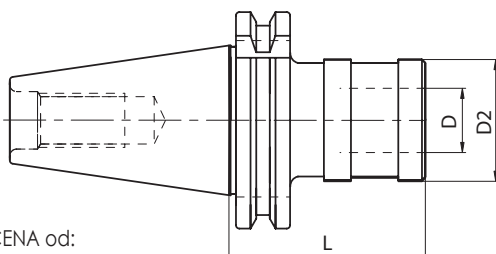

Isporučuje se bez čaura za navoj

| Kat. br. | Oznaka | ISO | SIZE | TOP RANGE | PRESS. | EXT. | D | D2 | L | CENA |
|----------|---------------|------|------|-----------|--------|------|----|----|----|-----------|
| M3010 | TC40H60GR1.DC | SK40 | 1 | M3-M12 | 9 | 9 | 19 | 38 | 60 | 15.480,00 |
| M3110 | TC40H92GR2.DC | SK40 | 2 | M6-M20 | 15 | 15 | 31 | 53 | 92 | 20.070,00 |
| M3310 | BT40H67GR1.DC | BT40 | 1 | M3-M12 | 9 | 9 | 19 | 38 | 67 | 16.340,00 |
| M3410 | BT40H93GR2.DC | BT40 | 2 | M6-M20 | 15 | 15 | 31 | 53 | 98 | 21.220,00 |



Set čaura tip ER



CENA od:
5.500,00

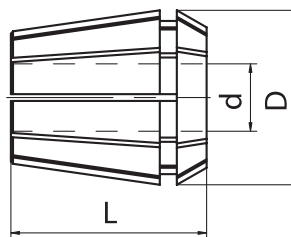

Preciznost $\leq 0,010$

| Kat. br. | Broj čaura u setu | Opseg čaura | CENA |
|-------------------|-------------------|---|------------------|
| SERIE-ER8 | (1÷5) 9 čaura | Ø 1-1,5-2-2,5-3-3,5-4-4,5-5 | 5.900,00 |
| SERIE-ER11 | (1÷7) 13 čaura | Ø 1-1,5-2-2,5-3-3,5-4-4,5-5-5,5-6-6,5-7 | 7.340,00 |
| SERIE-ER16 | (1÷10) 10 čaura | Ø 1-2-3-4-5-6-7-8-9-10 | 5.500,00 |
| SERIE-ER20 | (2÷13) 12 čaura | Ø 2-3-4-5-6-7-8-9-10-11-12-13 | 6.200,00 |
| SERIE-ER25 | (2÷16) 15 čaura | Ø 2-3-4-5-6-7-8-9-10-11-12-13-14-15-16 | 10.240,00 |
| SERIE-ER32 | (3÷20) 18 čaura | Ø 3-4-5-6-7-8-9-10-11-12-13-14-15-16-17-18-19-20 | 10.060,00 |
| SERIE-ER40 | (4÷26) 23 čaura | Ø 4-5-6-7-8-9-10-11-12-13-14-15-16-17-18-19-20 21-22-23-24-25-26 | 16.970,00 |

Set čaura za visok pritisak

Max 120BAR

DIN6499/ISO 15488

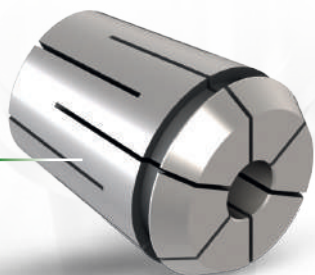

CENA od:
9.700,00

Za burgije i glodala sa
unutrašnjim hlađenjem

| Kat. br. | Opseg čaura | CENA |
|----------------------|---------------------------|------------------|
| SERIE - ERC25 | Ø 4, 6, 8, 10, 12, 16 | 9.700,00 |
| SERIE - ERC32 | Ø 4, 6, 8, 10, 12, 16, 20 | 11.800,00 |

Preciznost $\leq 0,010$

KINTEK®

Fridro alati d.o.o.

Šumadijska 8
34103 Kragujevac
Tel.: 034 355 962
Tel.: 034 540 488
Email: fridro@mts.rs

Ponuda važi do isteka zaliha
Cene su u RSD i bez PDV-a

ČAURE



U slučaju odstupanja od cene ili tehničkih podataka blagovremeno ćemo Vas obavestiti.

Kod porudžbina manjih od 8.000 RSD bez PDV trošak slanja robe zaračunavamo na račun kupca. Pri štampanju može doći do grešaka na koje ne možemo uticati i za koje ne odgovaramo. Hvala na razumevanju.