

FRIDRO *Alati*



KONUSNI
TRNOVI I
ČAURE



8 2024

KINTEK[®]

Sve cene su u
RSD i bez PDV-a



STEZNI ALAT



Važi do isteka zaliha

Konusni trn- futer SK40/DIN 69871

DIN 69871 ADB

252-11301
252-11302



Preciznost 0.05mm
Pogodan za desnu i levu rotaciju do 7000 obrtaja u minuti

DIN 69871 ADB

252-11211
252-11212



Preciznost 0.05mm
Ne koristi se u okretanju u smeru suprotnom smeru kazaljke na satu

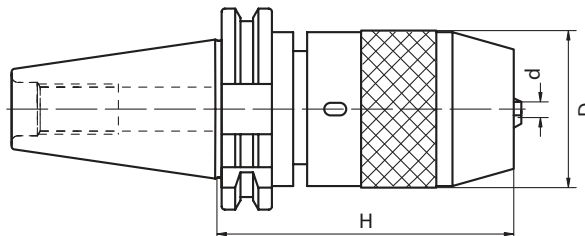

Kat. br.	Oznaka	ISO	H	D	Opseg stezanja	Ključ	CENA
252-11211	TC40H95R1-13	SK40	95	50	1-13	816-111024	13.750,00
252-11212	TC40H115R3-16	SK40	115	57	3-16	816-111025	14.950,00
252-11301	TC40H90R1-13X	SK40	90	50	1-13	816-152001	20.100,00
252-11302	TC40H95R3-16X	SK40	95	57	3-16	816-152001	20.950,00

Konusni trn- futer MAS BT40

JIS-B 6339 MAS 403/BT A

252-11501
252-11502



Preciznost 0.05mm
Ne koristi se u okretanju u smeru suprotnom smeru kazaljke na satu

JIS-B 6339 MAS 403/BT A - MAS 403BT/ADB

252-11410
252-11411

Preciznost 0.05mm
Pogodan za desnu i levu rotaciju do 7000 obrtaja u minuti



CENA od:
14.360,00

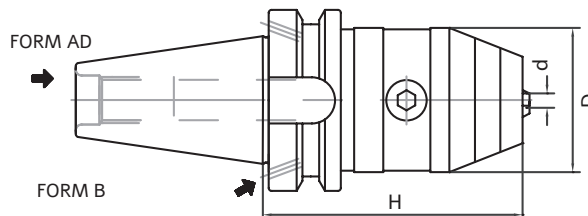

Kat. br.	Oznaka	ISO	H	D	Opseg stezanja	Ključ	CENA
252-11501	BT40H95R1-13	BT40	95	50	1-13	816-111024	14.360,00
252-11502	BT40H115R3-16	BT40	115	57	3-16	816-111025	15.420,00
252-11410	BT40H98R1-13X	BT40	98	50	1-13	816-152001	20.100,00
252-11411	BT40H103R3-16X	BT40	103	50	3-16	816-152002	22.870,00

Konusni trn- futer

DIN 69893 A+C

252-11733



Preciznost 0.05mm
Pogodan za desnu i levu rotaciju do 8000 obrtaja u minuti

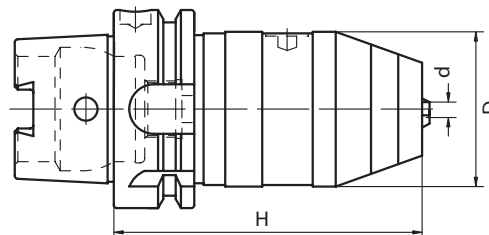

CENA
30.800,00

HSK	Kat. br.	Oznaka	H	D	Opseg stezanja	Ključ	CENA
63	252-11733	HSK63AH105R1-13X	105	50	1-13	816-152001	30.800,00

JIS-B 6339 MAŠ 403/BT AD - DIN6499/ISO15488

214-31502

DIN 69871 AD - DIN6499/ISO15488

214-31202

CENA

4.590,00

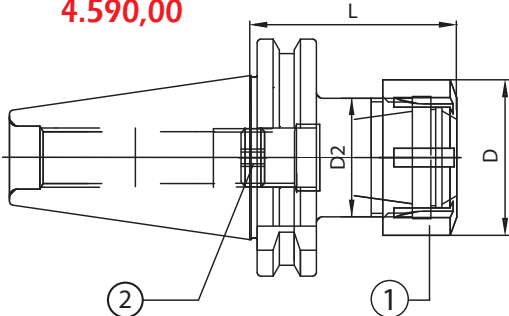

G6,3
15000 RPM

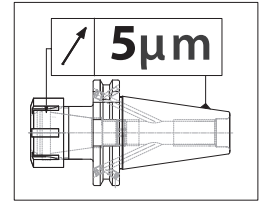
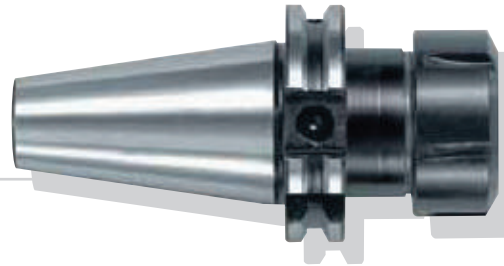

Kat. br.	Oznaka	ISO	ER	D	D2	L	CENA
214-31202	TC40H70ER32	SK40	32	50	40	70	4.590,00
214-31502	BT40H70ER32	BT40	32	50	40	70	4.590,00

Konusni trn HSK63

CENA

8.750,00

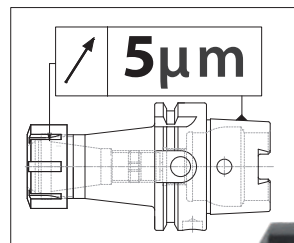
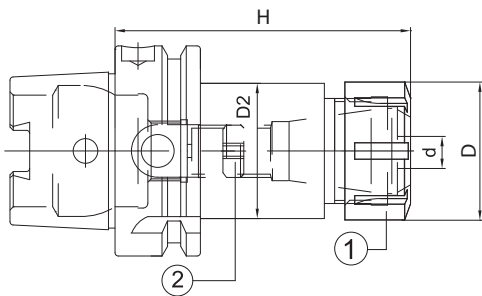

214-31707
214-31708

DIN 69893 A+C - DIN6499/ISO15488

G6,3
20000 RPM



HSK	Kat. br.	Oznaka	H	d	D	ER	D2	CENA
63	214-31707	HSK63AH100ER25	100	1÷16	42	25	41,5	8.750,00
63	214-31708	HSK63AH100ER32	100	2÷20	50	32	49,5	8.750,00

Konusni trn za rezanje navoja

JIS-B 6339 MAŠ 403/BT A

M3310

DIN 69871 A

M3010

CENA od:

13.700,00

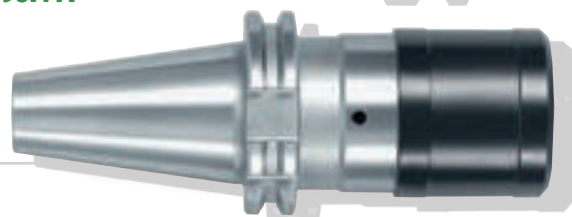
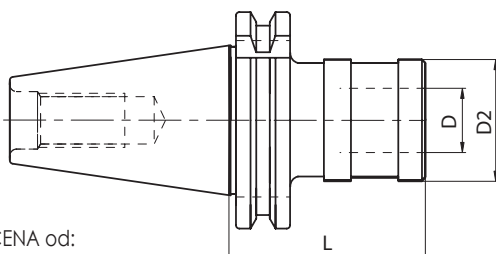

Isporučuje se bez čaura za navoj

Kat. br.	Oznaka	ISO	SIZE	TOP RANGE	PRESS.	EXT.	D	D2	L	CENA
M3010	TC40H60GR1.DC	SK40	1	M3-M12	9	9	19	38	60	13.700,00
M3110	TC40H92GR2.DC	SK40	2	M6-M20	15	15	31	53	92	17.800,00
M3310	BT40H67GR1.DC	BT40	1	M3-M12	9	9	19	38	67	14.480,00
M3410	BT40H93GR2.DC	BT40	2	M6-M20	15	15	31	53	98	18.740,00

Set čaura
tip ER



CENA od:
5.200,00

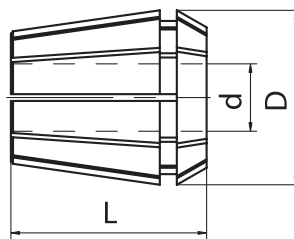

Preciznost $\leq 0,010$

Kat. br.	Broj čaura u setu	Opseg čaura	CENA
SERIE-ER8	(1÷5) 9 čaura	Ø 1-1,5-2-2,5-3-3,5-4-4,5-5	5.900,00
SERIE-ER11	(1÷7) 13 čaura	Ø 1-1,5-2-2,5-3-3,5-4-4,5-5-5,5-6-6,5-7	7.010,00
SERIE-ER16	(1÷10) 10 čaura	Ø 1-2-3-4-5-6-7-8-9-10	5.200,00
SERIE-ER20	(2÷13) 12 čaura	Ø 2-3-4-5-6-7-8-9-10-11-12-13	5.900,00
SERIE-ER25	(2÷16) 15 čaura	Ø 2-3-4-5-6-7-8-9-10-11-12-13-14-15-16	7.700,00
SERIE-ER32	(3÷20) 18 čaura	Ø 3-4-5-6-7-8-9-10-11-12-13-14-15-16-17-18-19-20	9.650,00
SERIE-ER40	(4÷26) 23 čaura	Ø 4-5-6-7-8-9-10-11-12-13-14-15-16-17-18-19-20-21-22-23-24-25-26	16.200,00

Set čaura za visok pritisak
Max 120BAR

DIN6499/ISO 15488

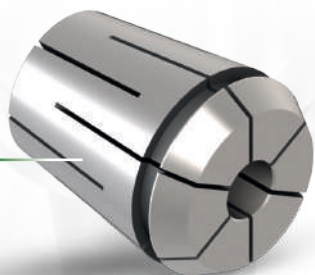

CENA od:
9.700,00

Za burgije i glodala sa
unutrašnjim hlađenjem

Kat. br.	Opseg čaura	CENA
SERIE - ERC25	Ø 4, 6, 8, 10, 12, 16	9.700,00
SERIE - ERC32	Ø 4, 6, 8, 10, 12, 16, 20	11.800,00

Preciznost $\leq 0,010$

KINTEK®

ČAURE



U slučaju odstupanja od cene ili tehničkih podataka blagovremeno ćemo Vas obavestiti.
Kod porudžbina manjih od 8.000 RSD bez PDV trošak slanja robe zaračunavamo na račun kupca.
Pri štampanju može doći do grešaka na koje ne možemo uticati i za koje ne odgovaramo.
Hvala na razumevanju.

E-mail: fridro@mts.rs