

# FRIDRO

ALATI



## STEZNI ALAT

Sve cene su u RSD i bez PDV-a

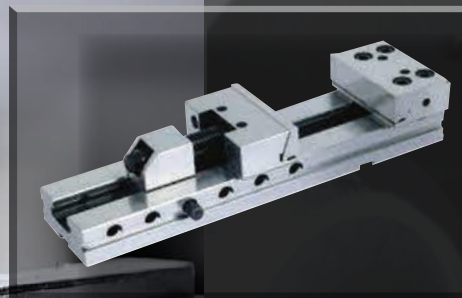

OŠTRENJE BURGIJA  
REZANJE NAVOJA  
OBARANJE IVICA



# MRCM

Šumadijska 8,  
34000 Kragujevac

E-mail: fridro@mts.rs

Tel.: 034 355 962  
Tel.: 034 540 488



[www.fridro.rs](http://www.fridro.rs)

Važi do isteka zaliha

12  
24

U slučaju odstupanja od cene ili tehničkih podataka blagovremeno ćemo Vas obavestiti.  
Kod porudžbina manjih od 8.000 RSD bez PDV-a trošak slanja robe zaračunavamo na račun kupca.  
Pri štampanju može doći do grešaka na koje ne možemo uticati i za koje ne odgovaramo. Hvala na razumevanju.



# MAŠINE ZA OŠTRENJE BURGIJA



**MRCM**

**MR-13A**  za oštrenje

CENA  
**35.300,00**

Model	Opseg burgije	Ugao burgije	Dimenzije (cm)	Brzina (rpm)	Snaga	Težina (kg)	Cena
<b>MR-13A</b>	Ø3-Ø13	95°-135°	32x18x19	4400	220V/120W	10	<b>35.300,00</b>

\* Sadrži čaure: Ø 3.0; 4.0; 5.0; 6.0; 7.0; 8.0; 9.0; 10.0; 11.0; 12.0; 13.0

**MR-26A**  za oštrenje



CENA  
**89.000,00**

**MRCM**

Model	Opseg burgije	Ugao burgije	Dimenzije (cm)	Brzina (rpm)	Snaga	Težina (kg)	Cena
<b>MR-26A</b>	Ø 13-Ø26	95°-135°	46x24x22	4400	220V/250W	31	<b>89.000,00</b>

\* Sadrži čaure: Ø 13.0; 14.0; 15.0; 16.0; 17.0; 18.0; 19.0; 20.0; 21.0; 22.0; 23.0; 24.0; 25.0; 26.0



Savitljiva glava

**DS16(U)-DIN**  
**DS30(U)-DIN**  za rezanje navoja

# MAŠINE ZA REZANJE NAVOJA

**MRCM**

Model	Veličina navoja	Snaga	Motor	Brzina (rpm)	Cena
<b>DS16(U)-DIN</b>	M3-M16	AC220V	600W	0-312	<b>110.000,00</b>
<b>DS30(U)-DIN</b>	M6-M30	AC220V	1200W	0-150	<b>147.000,00</b>



# MRCM

## MAŠINE ZA OBARANJE IVICA



**MR-R300** za obaranje ivica

CENA  
**60.200,00**



Pločice za R200 i R300

Model	Visina žleba (mm)	Ugao žleba	Dimenzije (cm)	Brzina (rpm)	Snaga	Težina (kg)	Cena
<b>MR-R300 (220V)</b>	0-3(6)	15° - 45°	54x39x30	2800	550W/380V/50H	36	<b>60.200,00</b>

**MR-R800B** za obaranje ivica



Pločice za R800



CENA  
**92.000,00**

# MRCM

Model	Visina žleba pravi deo (mm)	Ugao žleba pravi deo	Dimenzije (cm)	Brzina pravog dela (rpm)	Snaga	Težina (kg)	Cena
<b>MR-R800B</b>	0-3	15° - 45°	47x40x57	8500	380V/50H/3 faza/750W	63	<b>92.000,00</b>
	Visina žleba zakrivljeni deo (mm)	Ugao žleba zakrivljeni deo	Dimenzije pakovanja (cm)	Brzina zakrivljenog dela (rpm)		Težina pakovanja (kg)	
	0-2.5	45°	53x44x69	12000		70	

**MR-R200** za obaranje ivica



DO ISTEKA ZALIHA

# MRCM

Model	Visina žleba (mm)	Ugao žleba	Dimenzije (cm)	Brzina (rpm)	Snaga	Težina (kg)	Cena
<b>MR-R200</b>	0-3(6)	15° - 45°	41x29x27	3500	380V/750W/50H	14	<b>41.300,00</b>

CENA  
**41.300,00**



Pločice za R200 i R300

## Nosač za elastične čaure

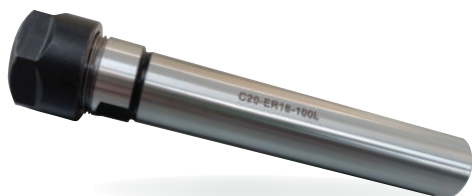

CENA od:  
**3.600,00**

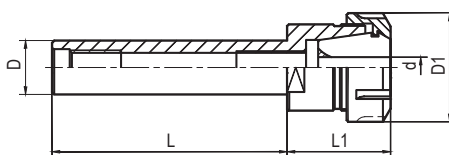

BER16  
BER25  
BER32

Sa cilindričnom drškom



Kat. br.	d	D	D1	L	L1	Cena
BER16-16X150-50	1-10	16	28	150	50	3.660,00
BER16-20X100-50	1-10	20	28	100	50	3.600,00
BER16-20X150-25	1-10	20	28	150	25	3.600,00
BER25-20X100-50	1-16	20	42	100	50	4.300,00
BER32-25X100-55	2-20	25	50	100	55	4.300,00

## Nosač za elastične čaure sa mini glavom



CENA od:  
**3.600,00**

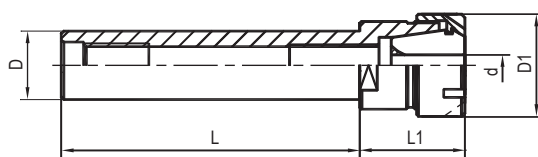

BER16M



Kat. br.	d	D	D1	L	L1	Cena
BER16M-16X150-40	1-10	16	22	150	40	3.600,00
BER16M-20X150-25	1-10	20	22	150	25	3.820,00

## Ključ za elastične čaure



CENA  
**670,00**

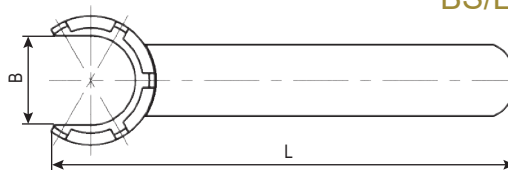

BS/ER16M



Kat. br.	B	L	Stežna matica	Cena
BS/ER16M	15	110	ER16-M	670,00

## Ključ za elastične čaure

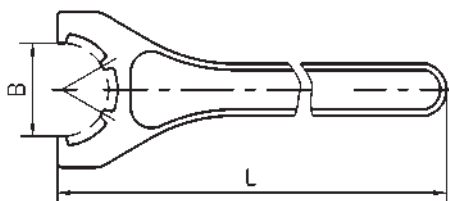

Ključ za stežanje čaura  
ER25, ER32, ER40



Kat. br.	B	L	Stežanje matica	Cena
BS/ER25-S	37	210	ER25-B ER25-T2	650,00
BS/ER32-S	45	250	ER32-B ER32-T2	650,00
BS/ER40-S	58	290	ER40-B ER40-T2	700,00

## Obrtni konus- pečurka za centriranje 60 - zarubljen BDS4X160X60

CENA  
**17.400,00**

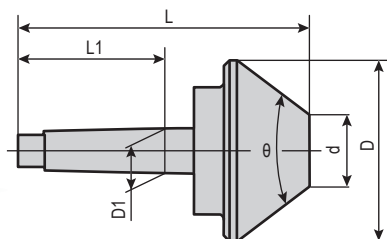

Kat. br.	Prihvati	$\theta$	D	D1	L	L1	d	Cena
BDS4x160x60°	MK4	60°	160	31.267	232	102.5	40	17.400,00

## Izbijač poluautomatski BDIN318

BDIN318



Kat. br.	Prihvati	Ukupna dužina	Cena
BDIN318/1-3	MK1 MK2 MK3	317	2.300,00
BDIN318/4-6	MK4 MK5 MK6	380	2.500,00



## Stega mehanička precizna modularna

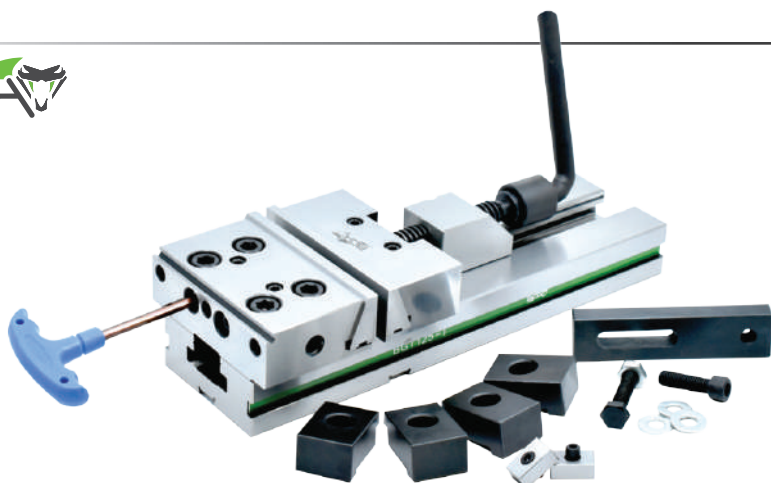

- Opis:
- Izradjeno od čelika visokog kvaliteta, HRC58-62
  - Paralelnost 0.005mm/100mm
  - Lako podešavanje stezaljki
  - Paralelne čeljusti

Kat. br.	Sila stezanja kg	Širina čeljusti mm	Visina čeljusti mm	Smax- otvaranje mm	Dužina mm	Cena
BGT125-I	3000	125	40	150	345	36.000,00
BGT150A-I	5000	150	50	200	420	47.000,00
BGT150B-I	5000	150	50	300	520	52.300,00

## Stega mehanička precizna modularna

- Opis:
- Izradjeno od čelika visokog kvaliteta, HRC58-62
  - Paralelnost 0.005mm/100mm
  - Lako podešavanje stezaljki
  - Paralelne čeljusti

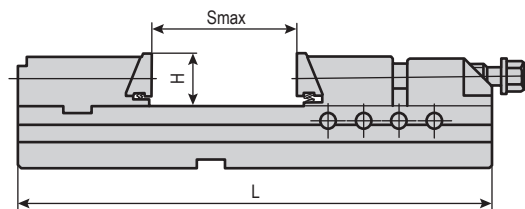
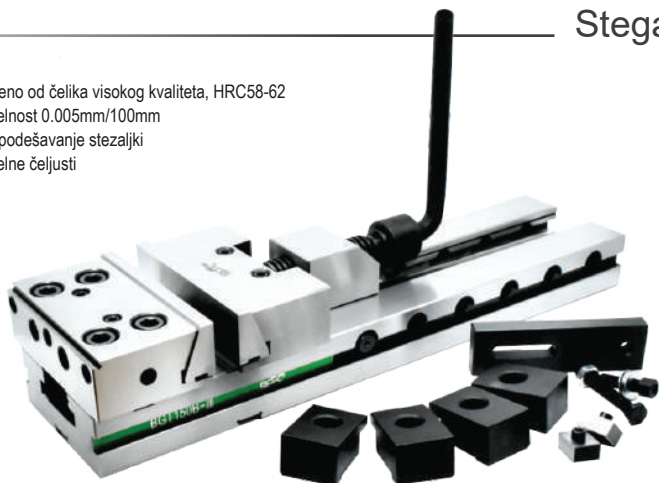

Kat. br.	Sila stezanja kg	Širina čeljusti mm	Visina čeljusti mm	Smax- otvaranje mm	Dužina mm	Cena
BGT125-III	3000	125	40	150	345	36.000,00
BGT150B-III	5000	150	50	300	520	52.300,00

## BQGG

Paralelnost: 0,005/ 100mm



Opis:

- Izrađeno od visokokvalitetnog čelika
- Površinska tvrdoća 58- 62 HRC
- Brzo stezanje i lako rukovanje, garantuje visoku tačnost u svim položajima

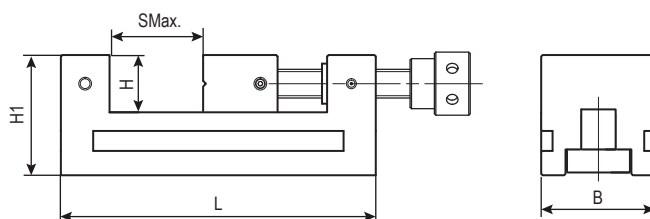

Kat. br.	B mm	H mm	H1 mm	Smax mm	L mm	Težina kg	Cena
BQGG50	50	25	50	65	155	3.0	7.600,00
BQGG73C	73	35	74	100	210	5.0	11.700,00

## BQKG73C/QKG73A

CENA  
8.900,00

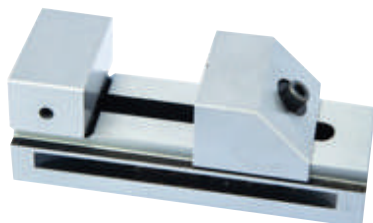

## Stega ručna precizna

Bočni utor

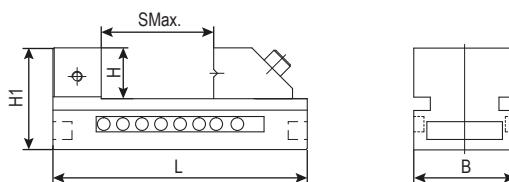

Kat. br.	B mm	H mm	H1 mm	Smax mm	L mm	Wt kg	Cena
BQKG73C/QKG73A	73	35	67	100	190	4.1	8.900,00



## Stega mehaničko- hidraulična



### Opis

- Mehaničko/hidraulično vreteno
- Velika širina stezanja
- Brzo i jednostavno prilagodjavanje raspona
- Od kaljenog čelika



PHV-130  
PHV-160

### Upotreba:

Za stezanje radnih komada na mašinama

Kat. br.	Širina čeljusti mm	Stezna sila kN	Raspon mm	Dužina mm	Težina kg	Cena
PHV-130	130	36	0-220	570/795	36	81.200,00
PHV-160	160	41	0-300	690/940	56	89.300,00

## Montažni blok- držač konusa

horizontalni i vertikalni

CENA od:

5.600,00



BLD-BT40  
BLD-DT40



Kat. br.	Težina kg	Konus nosača alata	Veličina mm	Cena
BLD-BT40	3.80	BT40	205x98.5x128	5.600,00
BLD-DT40	3.80	DIN69871 SK40	205x98.5x128	5.600,00

## Stega mašinska



CENA

19.700,00



BQ12160

Kat. br.	Širina paknova mm	Visina paknova mm	Max. otvaranje mm	Dimenzije cm	Cena
BQ12160	160	52	125	450X240X250	19.700,00

## Stega za stubnu bušilicu

Performanse i karakteristike:

- Dobra čvrstoća stezanja
- Lagan za rukovanje i stabilan za rad



BQ19125

CENA

5.200,00



Kat. br.	Širina paknova mm	Visina paknova mm	Max. otvaranje mm	Dimenzije cm	Cena
BQ19125	125	26	100	41x30.5x33	5.200,00

## Petoosna stega

CNX75150

CENA

CNX100350

106.000,00

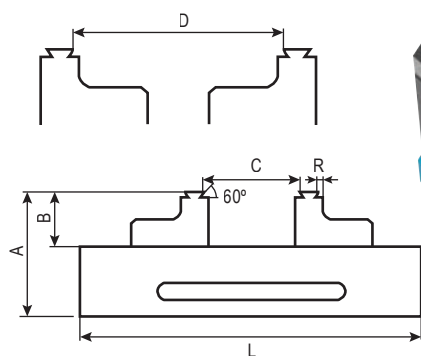

mm

Kat. br.	C Min-Max	D Min-Max	A	B	R	L	Cena
CNX75150	0-150	65-200	73	32	3	235	106.000,00

## Stega mašinska okretno- nagibna

Opis:

- Tri načina zaustavljanja
- Izradjeno od kvalitetnog livenog gvozdja
- Paralelnost 0.025mm/100mm



CENA

44.750,00

BQW125

Kat. br.	Max. otvaranje	Širina čeljusti	Visina čeljusti	Cena
BQW125	125	125	40	44.750,00

## Leteći šiljak- kirner precizni

B604H..



CENA od:  
**5.950,00**

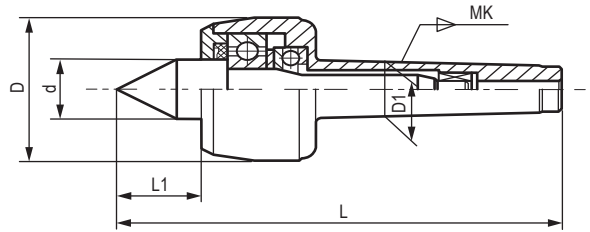

Kat. br.	Konus	L mm	D mm	L1 mm	d mm	D1 mm	Maksimalno opterećenje	Maksimalna brzina	Tačnost	Cena
B604H/102	MK2	129	45	24	20	17.780	200	7000	0.005	5.950,00
B604H/104	MK3	151.5	50	27.5	22	23.825	400	6300	0.005	7.100,00
B604H/108	MK4	205	70	41	32	31.267	800	3800	0.005	8.200,00
B604H/110	MK5	258.5	90	50.5	40	44.399	2000	3000	0.005	12.800,00

## Leteći šiljak- kirner precizni sa dužim obrtnim vrhom

BM11..



CENA od:  
**6.000,00**

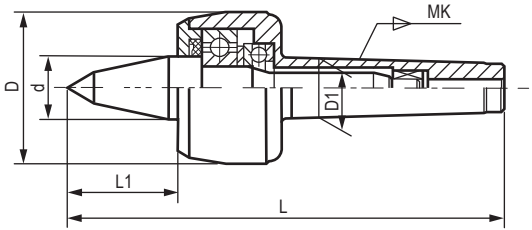

Kat. br.	Konus	L mm	D mm	L1 mm	d mm	D1 mm	Maksimalno opterećenje	Maksimalna brzina	Tačnost	Cena
BM11/102	MK2	139	45	34	20	17.780	140	7000	0.005	6.000,00
BM11/106	MK3	176.5	60	47	25	23.825	400	5000	0.005	7.950,00
BM11/108	MK4	217	70	53	32	31.267	500	3800	0.005	8.500,00
BM11/110	MK5	273	90	65	40	44.399	1200	3000	0.005	11.750,00

Koristi se kod glodalica, bušilica, strugova

## Borfuter- brzostežuća glava

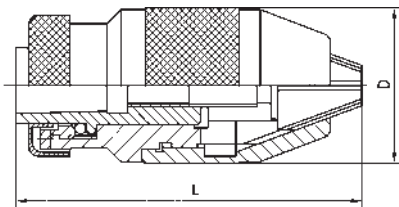

Kat. br.	Raspon	Prihvat	D mm	L mm	Cena
BJ0106	0.5-6mm	B10	34	72	2.650,00
BJ0108	0.5-8mm	B12	42	82	2.650,00
BJ0110	1-10mm	B12	42	82	2.300,00
BJ0113	1-13mm	B16	44	97	2.350,00
BJ0116A	3-16mm	B16	54	110	2.650,00
BJ0120	5-20mm	B22	60	125	3.950,00

## Leteći šiljak- kirner sa 7 višenamenskih nastavaka



BD434A

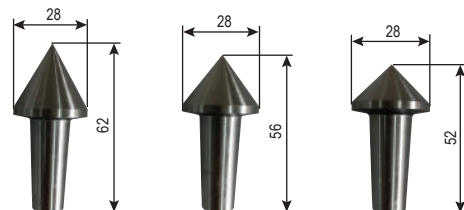
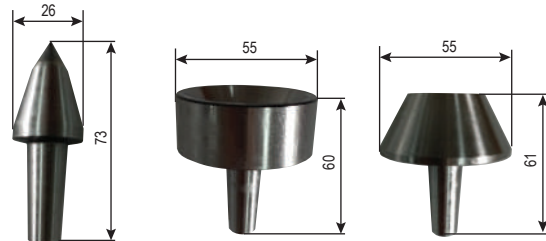
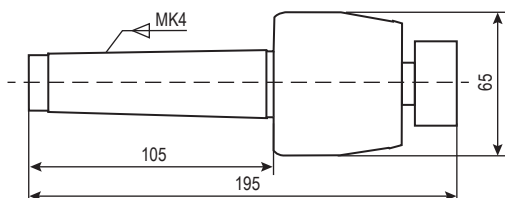

BD433A  
BD434A  
BD435

Kat. br.	Konus	Cena
BD433A	MK3	8.900,00
BD434A	MK4	13.800,00
BD435	MK5	16.200,00

## Stezni elementi osnovni asortiman



### Sadržaj garniture:

- 6 kom.- T matica
- 4 kom.- sigurnosne matice
- 12 kom.- sigurnosnih blokova
- 6 kom.- pribornica
- 6 kom.- stepenastih stezaljki
- 24 kom.- navojna klina

CENA  
**9.850,00**

**BYT-0204**

Kat. br.	Veličina kanala mm	Cena
BYT-0204	12x14	9.850,00

Kat. br.	Prečnik otvora	Set (kom.)	Cena
BER16-K10	1,2,3,4,5,6,7,8,9,10	10	6.300,00
BER20-K12	2,3,4,5,6,7,8,9,10,11,12,13	12	6.600,00
BER25-K15	2,3,4,5,6,7,8,9,10,11,12,13,14,15,16	15	8.000,00
BER32-K18	3,4,5,6,7,8,9,10,11,12,13,14,15,16,17,18,19,20	18	11.800,00
BER40-K23	4,5,6,7,8,9,10,11,12,13,14,15,16,17,18,19,20,21,22,23,24,25,26	23	17.200,00

## Podmetači- reporteri

BPB151-2  
BPB155-1



### Opis:

- Koristi se za tačno pozicioniranje
- Izradjeno od kaljenog legiranog čelika
- Tvrdoca: HRC55

Kat. br.	Tačnost	Dimenzije	Kom.	Cena
BPB151-2	0.01mm	160x4x10(14,18,22,26,30,34,38,42)	9x2	8.800,00
BPB155-1	0.01mm	120x4x10(16,18,20,22,24,26,28,30,32,35,40)	12x2	12.400,00

## Elastične čaure

BER..



### Opis:

- Čaure su u celosti kaljene i brušene
- Preciznost čaure: 15-20qm
- DIN 6499
- Korak 1mm

## Ekscentar glava ø 8~280

ZZ-001396

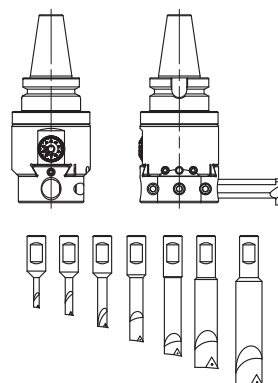
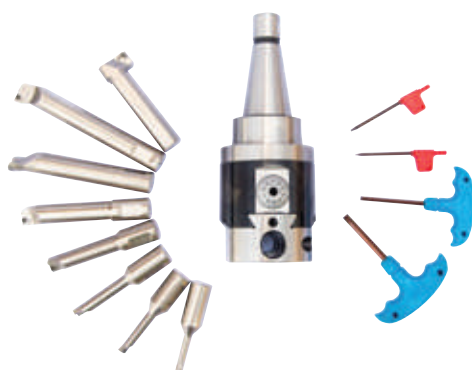

**FRIDRO**  
ALATI



Kat. br.	Opseg rupe	Stezni otvor	Tačnost	Max. hod klizača	Prihvat	Težina kg	Cena
BBT40-NBH2084	8-280	20	ø 0.01	25	BT40	9.5	46.700,00
BDIN.SK40-NBH2084	8-280	20	ø 0.01	25	DIN69871SK40	9.5	46.700,00
BDIN.SK50-NBH2084	8-280	20	ø 0.01	25	DIN69871SK50	12	46.700,00

Tip	Opseg rupe	Dubina	Pločice	Vijak	Ključ	Dubina rezanja ap	Posmak mm/obr.	Brzina rezanja mm/min.
SBJ2008-32	8-10	32	TBGT060102	M2x5	T6	0.05-0.20	0.05-0.10	100-200 Čelik 70-140 Prohrom 70-140 Liveno gvožđe 150-300 Aluminijum
SBJ2010-40	10-13	40	TBGT060104	M2.5x5	T8			
SBJ2012-53	12-17	53	TBGH090202					
SBJ2016-68	16-21	68	TBGH090204					
SBJ2020-83	20-130	83	TBGH110302 TBGH110304	M3x8	T8	0.10-0.25	0.07-0.15	
SBJ2025-96	25-135	96						
SBJ2030-115	30-140	115						
SBJ20L20-100	120-280	150						